



INTAKE SYSTEMS FOR VEHICLES LISTED ARE 50 STATE LEGAL. SEE KNFILTERS.COM FOR CARB STATUS ON EACH PART FOR A SPECIFIC VEHICLE.

INSTALLATION INSTRUCTIONS

57-6015
NISSAN
2004-08 Maxima
2004-06 Altima
V6-3.5

TOOLS NEEDED:

- Ratchet
- Extension
- 10mm Socket,
- 3/4" Wrench
- 17mm Wrench
- 10mm Wrench
- Flat Blade Screwdriver
- Pliers
- T20 Torx Wrench
- 5mm Allen Wrench
- 4mm Allen Wrench
- 3mm Allen Wrench

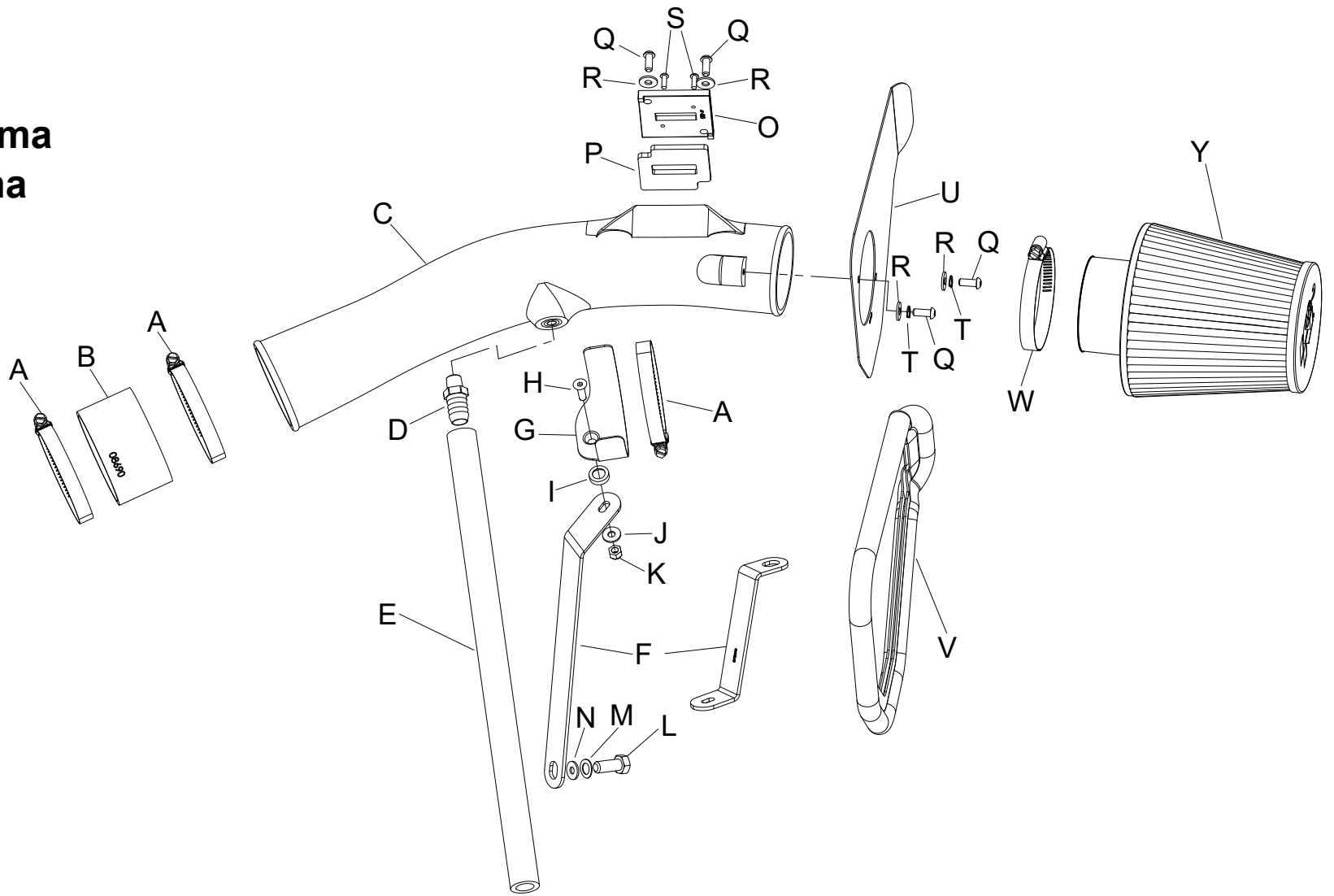

PARTS LIST:

Description	Qty.	Part #	Description	Qty.	Part #	Description	Qty.	Part #
A HOSE CLAMP; #48	3	08601	I WASHER; CONCIAL NYLON	1	08180	Q BOLT; M6 X 1 X 16MM	4	07730
B HOSE; 3.25"ID X 2"L	1	08690	J WASHER; 1/4"ID X 5/8"OD	1	08275	R WASHER; 6MM FLAT	4	08269
C INTAKE TUBE; (GN)	1	087213A	K NUT; 6MM NYLOCK	1	07512	S SCREW; M4-.7 X 12	2	07726
D FITTING; VENT 1/4"NPT	1	08911-2	L BOLT; M10 X 1.5 X 25MM	1	07702	T WASHER; 1/4" LOCK	2	08198
E HOSE; 5/8"ID X 17"L	1	08681	M WASHER; 10MM WAVE	1	08175	U HEAT SHIELD	1	07652
F BRACKET	1	06489 / 070090	N WASHER; 3/8" FLAT WASHER	1	08134	V EDGE TRIM; 30"L	1	102489A
G BRACKET; SADDLE	1	078855	O ADAPTOR; MAF SENSOR	1	21515-1	W HOSE CLAMP; #52	1	08610
H BOLT; M6-1.00 X 20MM	1	08376	P GASKET; 3/16" PORON	1	09069	Y AIR FITER	1	RU-4180

If you need any assistance please call 1-800-858-3333 to speak with a representative in our Customer Service Center before returning the product.

NOTE: FAILURE TO FOLLOW INSTALLATION INSTRUCTIONS AND NOT USING THE PROVIDED HARDWARE MAY DAMAGE THE INTAKE TUBE, THROTTLE BODY AND ENGINE.

TO START:

1. Turn off the ignition and disconnect the negative battery cable.
NOTE: Disconnecting the negative battery cable erases pre-programmed electronic memories. Write down all memory settings before disconnecting the negative battery cable. Some radios will require an anti-theft code to be entered after the battery is reconnected. The anti-theft code is typically supplied with your owner's manual. In the event your vehicles anti-theft code cannot be recovered, contact an authorized dealership to obtain your vehicles anti-theft code.



2. Remove the four bolts that retain the engine cover, then remove the engine cover from the engine.

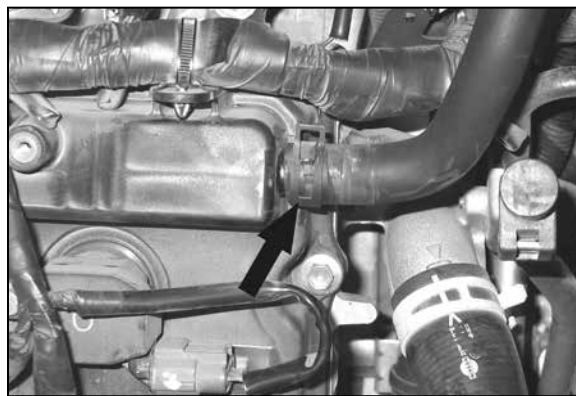

3. Release the spring clamp and disconnect the crank case vent hose.



4. Disconnect the mass air sensor electrical connection.



5. Loosen the two hose clamps that secure the stock intake tube to the throttle body and stock mass air sensor.

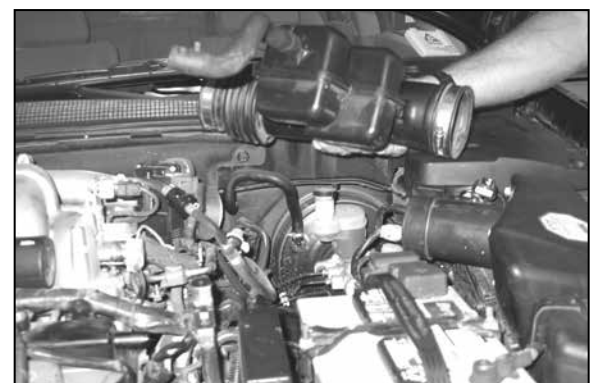

6. Remove the stock intake tube from the vehicle.



7. Remove the bolt that secures the air box to the inner fender.



8. Lift the air box up from the mounting grommets. Detach the air box from the fresh air duct, then remove the air box from the vehicle.

NOTE: K&N Engineering, Inc., recommends that customers do not discard factory air intake.



9. Install silicone hose (#08690) onto the throttle body and secure with the provided hose clamp.

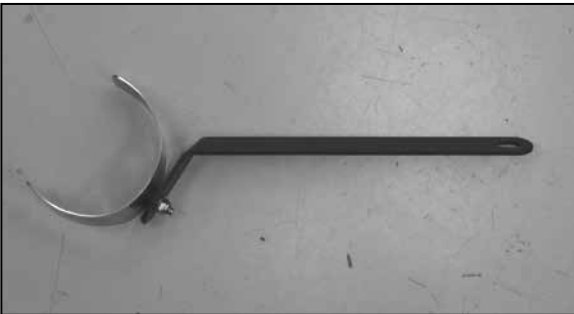

10. On 2004-2006 model vehicles, secure the saddle clamp to the tube mounting bracket (06489) with the provided hardware as shown.

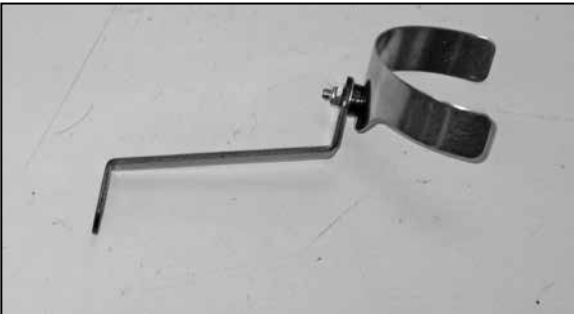

10a. On 2007 and later model vehicles, Secure the saddle clamp to the tube mounting bracket (070090) with the provided hardware as shown.

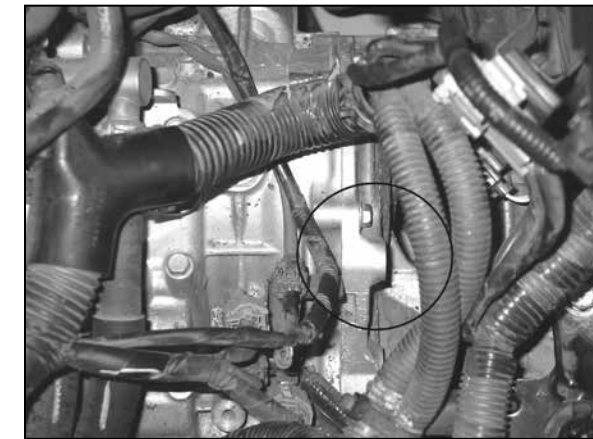
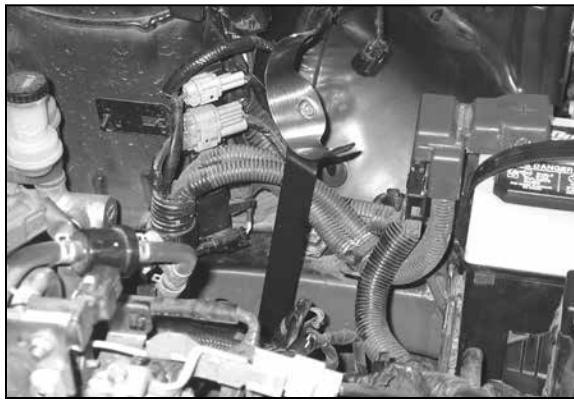

11. On 2004-2006 model vehicles, secure the tube mounting bracket assembly (06489) to the threaded boss on the transmission with the provided hardware.

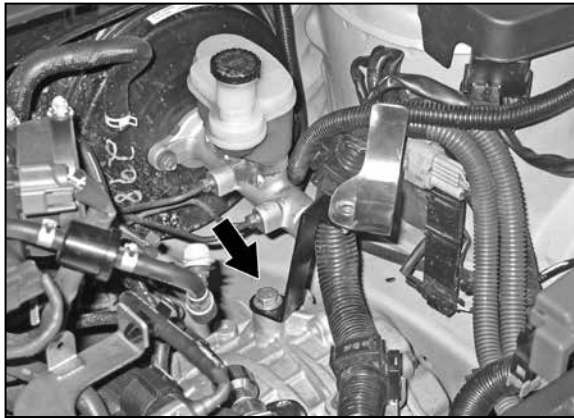

11a. On 2007 and later model vehicles, secure the tube mounting bracket assembly (070090).



12. Install the 1/4" NPT fitting into the K&N® intake tube as shown.

NOTE: NPT fitting has tapered threads and only designed to be installed until hand tight, then tighten ONE rotation or when the fitting becomes difficult to return.

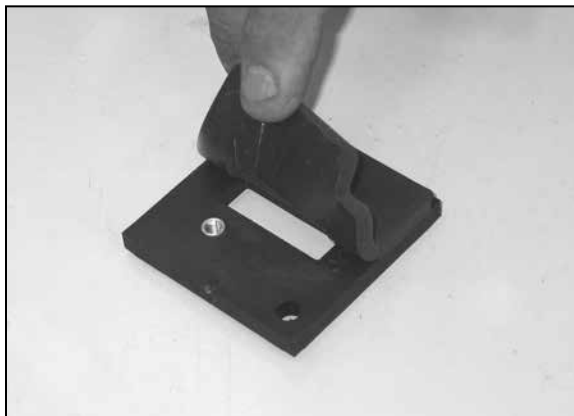

13. Install the provided gasket onto the K&N® mass air sensor adapter.

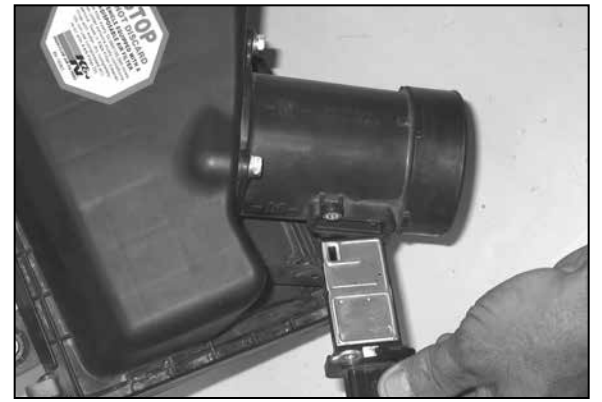

14. Remove the mass air sensor mounting screws. Then, remove the mass air sensor from the stock mass air sensor housing.

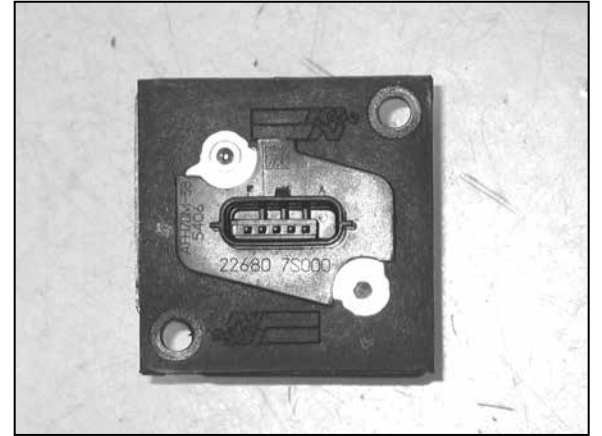

15. Install the mass air sensor into the K&N® mass air sensor adapter. Secure with the provided hardware.

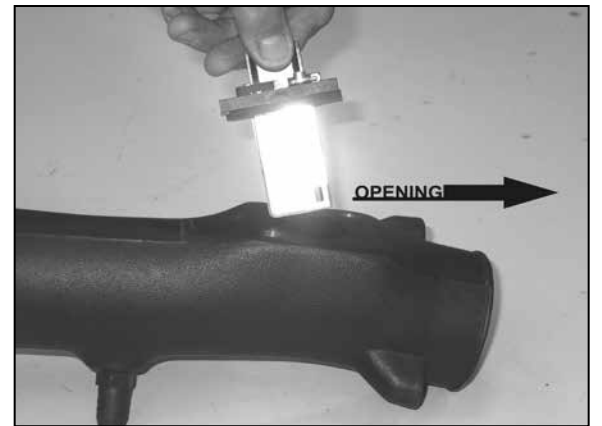

16. Install the mass air sensor assembly into the K&N® intake tube and secure with the provided hardware.

NOTE: The opening in the mass air sensor must be installed facing towards the inlet end of the tube as shown.



17. Install the provided edge trim onto the heat shield as shown.

NOTE: Some trimming of the edge trim may be necessary.



18. Secure the heat shield assembly to the K&N® intake tube with the provided hardware.



19. Install the K&N® intake tube assembly into the silicone hose at the throttle body and align with the saddle bracket installed in step #11. Secure the K&N® intake tube assembly with the provided hose clamps.



20. Install the provided crank case vent hose onto the vent port on the valve cover. Connect the open end to the 1/4" NPT fitting installed into the K&N® intake tube.



21. Re-install the engine cover and secure with the stock bolts.



22. Install the K&N® air filter and secure with the provided hose clamp.

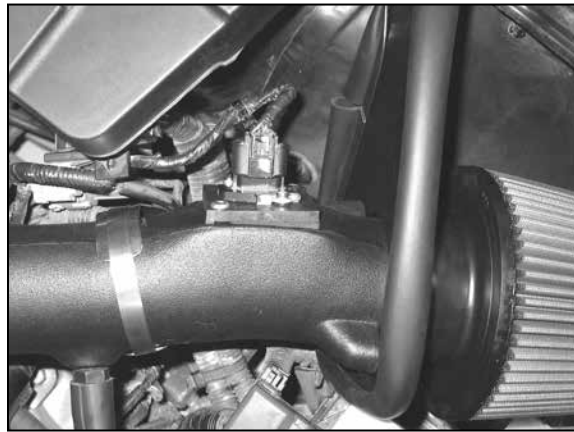

23. Re-connect the mass air sensor electrical connection.

24. Reconnect the vehicle's negative battery cable. Double check to make sure everything is tight and properly positioned before starting the vehicle.

25. The C.A.R.B. exemption sticker, (attached), must be visible under the hood so that an emissions inspector can see it when the vehicle is required to be tested for emissions. California requires testing every two years, other states may vary.

26. It will be necessary for all K&N® high flow intake systems to be checked periodically for realignment, clearance and tightening of all connections. Failure to follow the above instructions or proper maintenance may void warranty.

ROAD TESTING:

1. Start the engine with the transmission in neutral or park. Listen for air leaks or odd noises. For air leaks secure hoses and connections. For odd noises, find cause and repair before proceeding. This kit will function identically to the factory system except for being louder and much more responsive.

2. Test drive the vehicle. Listen for odd noises or rattles and fix as necessary.

3. If road test is fine, you can now enjoy the added power and performance from your kit.

4. K&N Engineering, Inc., requires cleaning the intake system's air filter element periodically for excessive dirt build-up. When used in harsh terrain conditions or off-road environments, our filters will require cleaning more often. We recommend that you visually inspect your filter more frequently when used in harsh terrain conditions to determine if the screen is still visible. When the screen is no longer visible some place on the filter element, it is time to clean it. To clean and re-oil, purchase our filter Recharger® service kit, part number 99-5050 or 99-5000 and follow the easy instructions.

**LEGAL IN CALIFORNIA ONLY FOR RACING VEHICLES
WHICH MAY NEVER BE USED, REGISTERED
OR LICENSED FOR USE UPON A HIGHWAY.**

See knfilters.com for CARB status on each part for a specific vehicle